

GPS_DESIGNER Personal Navigator

User manual and Reference guide

HN-2000

WARNINGS

Some certain knowledge is required to be well known by the user for proper and safe use of GPS_DESIGNER GPS handheld receiver. Please read this User's Manual first before operation.

This product can help the user to find out his way and orient him in travelling, BUT it can not totally replace the user's own personal judgement. Never lose your own reasonable judgement and solely rely on one device.

Because GPS_DESIGNER is an assistant device, it will NOT undertake any legal responsibility for any accident or damage caused by the user's wrong operation and/or wrong judgement in navigating with GPS_DESIGNER.

CAUTION

The Global Positioning System(GPS) is a system of 24 satellites which circle the earth twice a day in a very precise orbit and transmit information to earth. The GPS_DESIGNER must continuously find at least three of these satellites to calculate your position and your movement.

This GPS system is operated by the government of the United States, which is solely responsible for its accuracy and maintenance. Any changes of the system could affect the accuracy and performance of all GPS equipment.

Introduction

Welcome to GPS_DESIGNER

Thank you for choosing GPS_DESIGNER GPS handheld receiver!
It will never let you lose yourself no matter where you are.
Take it now
-----it can be your best friend!

Application Conditions:

GPS_DESIGNER is designed for outdoors navigation in the temperature range of -20°C ~ 70°C . So please use GPS_DESIGNER at an open place with a clear sky in the suitable environment since the surrounding environment will surely affect the satellite signals reception and device work efficiency.

Introduction section gives you a general overview of GPS_DESIGNER features.

Reference section tells how to operate the unit to locate and record your position, how to set up a route or record a track, and how to be guided with this unit specifically in more details.

Standard Package:

- A GPS_DESIGNER GPS handheld receiver
- A User's Manual



If you find something missing or damaged with the reference to the standard package, please contact the local dealer or retailer.

- *Unit Features*
- *Battery installation & Keypad*
- *Start up the unit*
- *Operation Structure*
- *Main pages*

Internal GPS

Antenna

LCD Display
(with back-light)

POWER

keypad

UP / DOWN /
RIGHT / LEFT / ENTER
keypads

ESCAPE

keypad



Waterproof
housing

Battery
Compartment



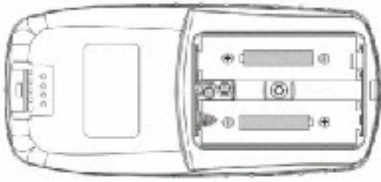

Battery Installation

1. Turn battery cover screw counterclockwise until the battery cover can be removed.
2. Insert two new AA(or rechargeable) 1.5 V batteries as shown in the left picture, be sure to check the polarity, and replace the battery cover.
3. Replace the screw and turn the screw clockwise until the battery cover is held securely. While the battery cover does provide the waterproofing seal to the batteries, you should avoid over-tightening the battery door screw.

NOTE: Battery life varies due to variety of factors, including temperature and back-lighting usage. Rechargeable batteries can also be used except that batteries state is not always correctly informed in the GPS_DESIGNER. An internal lithium battery will retain your data while you're changing AA(or rechargeable) batteries.



ESCAPE key

- switches among four main pages
- cancels current operation
- backs to last step or last page



POWER key

- turns the unit off and on
- turns the back-light off and on



UP / DOWN / RIGHT / LEFT / ENTER key

- highlights menu options and enters data
- controls cursor movement on the map page
- adjusts screen lightness and map display scale
- initiates entry and accepts the selected value
- enters MENU page

To start up the GPS_DESIGNER, you should take the unit outside and find an open area where the built-in antenna has a clear view of the sky.

Turning the GPS_DESIGNER on

1. Press POWER key until you hear a sound of “B” and the Welcome page appears.
2. Press ESCAPE key continuously, the four main pages come out in order. Press ENTER key from some of these main pages, you can enter MENU page and start operation as stated below.

Turning the GPS_DESIGNER off

Press and hold POWER key for about 3 seconds until the screen goes blank.

Turning the back-lighting

In any step of the operation, just press POWER key to turn it on and off.

WELCOME

SEARCHING 26 s

Press ESC key
to enter !

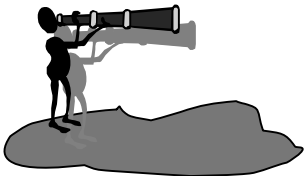

NOTE: When you use the unit for the first time, it will take 5 minutes to track the satellites and fix position for the unit. After the first use, it will only take you less than one minute at the beginning for each time .

If batteries do not have enough power to support the unit operation at the very beginning, the unit will alarm and turn off in about two minute automatically.

REFERENCE

Operation Structure

The GPS_DESIGNER operation is organized into four main pages: the Satellite Page, the Navigation page, the Position Page, and the Map Page. Normally, every time you turn on the GPS_DESIGNER, you'd better switch into Satellite page and check satellites status first then start operation.

When you press POWER key to start up the unit, you can press ESCAPE key to switch among these four main pages. And from these main pages, press ENTER key, the unit pops up the Menu page. Here you could select specific section you want to enter and make further operation.

In the Menu page, there are twelve options: MARK, W_LIST, R_LIST, T_LIST, P_WPT, SETUP, MEASURE, FIND, H & F, S & M, TOOLS, COMMU. Press UP / DOWN key to highlight the option you want, and then press ENTER key, you are able to go on further operation. Or press ESCAPE key in the Menu page, you can withdraw from Menu page and back to those four main pages. If you want to lock the screen, press long up key; unlock the screen, press long up key.

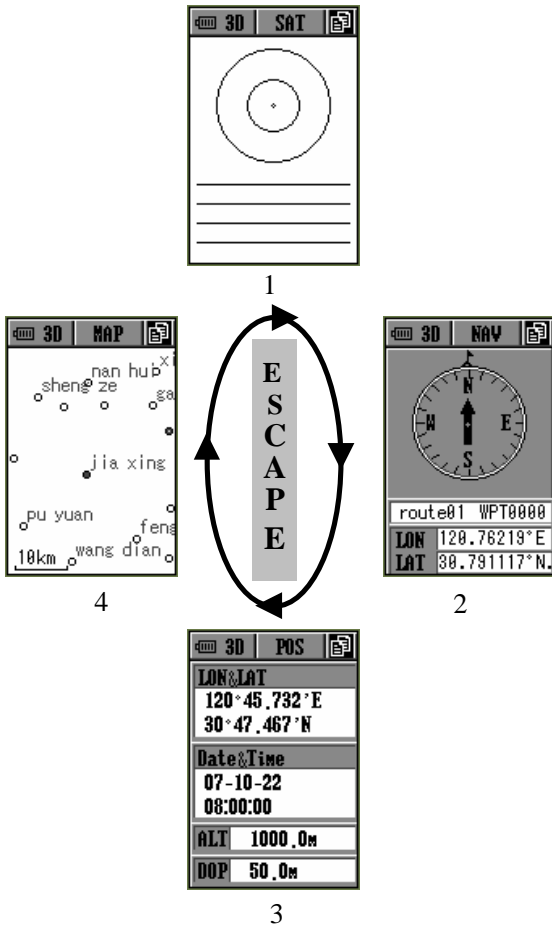

Operation Structure

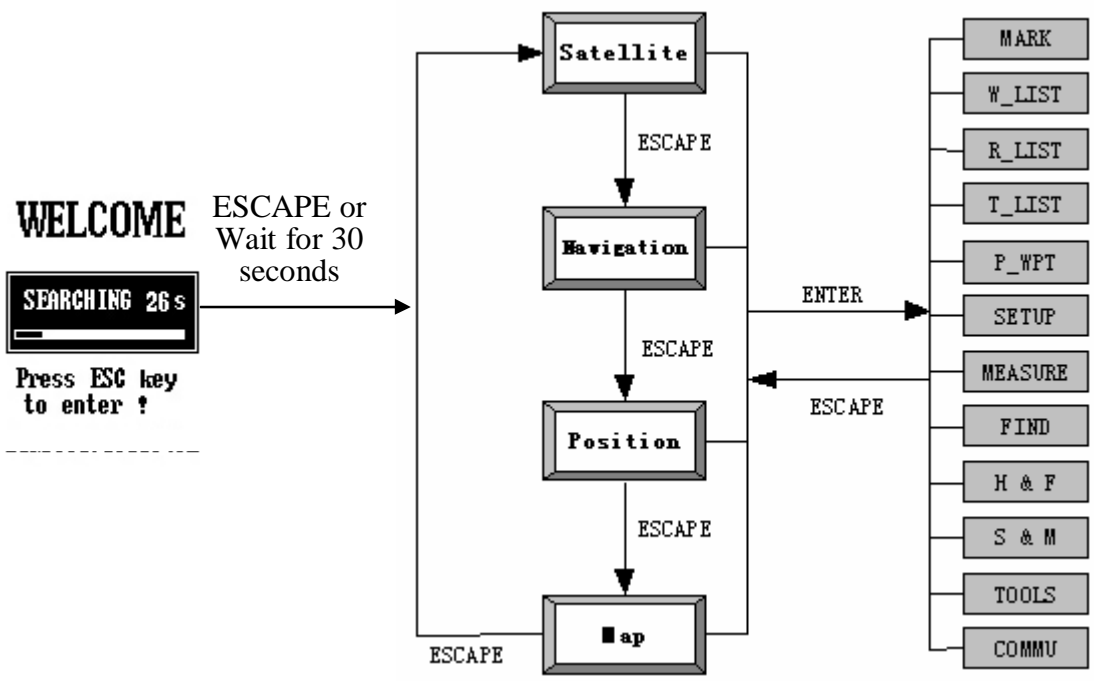

The Satellite page

- This page informs you mainly on the satellites distribution and satellite signal strength. Normally, the unit needs at least three satellites in connection for data processing. You should check the icon at the left top of this page first. It plays the same role as defined in the Position page.

- Here two circles are used to describe satellites distribution scope. All satellites will scatter within or along the bigger circle. If the satellite icon is blank, this satellite is just found; if it is filled with blackness, its signal is engaged in data processing.

- The columns in the half lower part of the page tell you the strength of satellites signals. The higher the column, the stronger the signal. If the column is blank, it means this satellite signal does not take part in location computing. Below the column is the satellite ID number. The Signal-to-Noise show the Signal of the GPS.

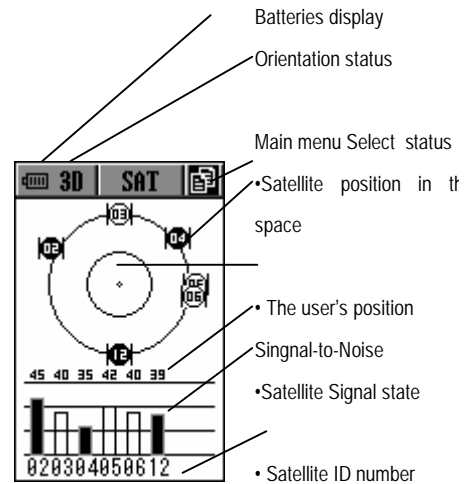



The Navigation page

This page makes very essential direction when you are under navigation. It orients you to your destination, tells you how far away you are from your destination, and your actual movement speed, and the route or track name you are using for navigation. The arrow in the middle always points to the direction you are advancing (in another word, it is Head-up direction). So you can judge your moving direction by the compass. Once you stop advancing, the arrow will return to North after 2-3 seconds. The dot in the ring shows the reference orientation of next waypoint or destination.

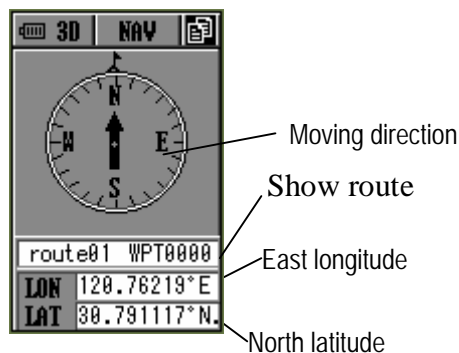
It displays the information about your current location, including longitude, latitude, COG, SOG ,etc, you can use the UP/ DOWN keypads to choose the content.



NOTE:

- The date and time here is collected from the satellite, there is no clock in GPS_DESIGNER.
- At the left top of the page, the icon of  means all the information displayed is **invalid**; but the icon of  means **valid**. **So it is very important for you to check this icon during operation.**

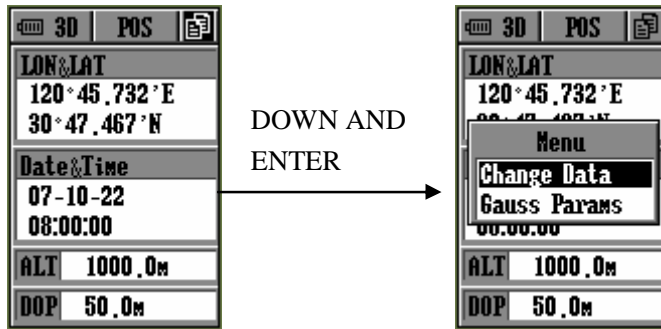

The Position page

This page shows the current location of the main information and time information.

Then can use **up/down** button to select the district or the provision of data definition Gaussian parameters.

Under the definition of data by **Enter** key areas, the system automatically selected **latitude** and **longitude**, according to **Enter** key pop-up pages can choose or plane coordinates of **latitude**, **longitude** coordinates.

Gaussian parameters set by **Enter**, the system set up pages pop Gaussian parameters, you can set up inside the parameters of good keeping can be installed, automatically returned to **the Position page**.

Gaussian parameters:

- Yf: things deviation units: m
- Lf: Central Meridian
- Df: projection ratio (usually set to 1.0 or 0.9996)
- Xf: North-South bias unit: m (usually 0)

Yf, Lf, Df, Xf for modification of data, between the four of the **Enter** key sequence can be used to choose, every available place in the **left / right** to choose, and use **up / down** keys to change, after the completion of revision can be preserved.

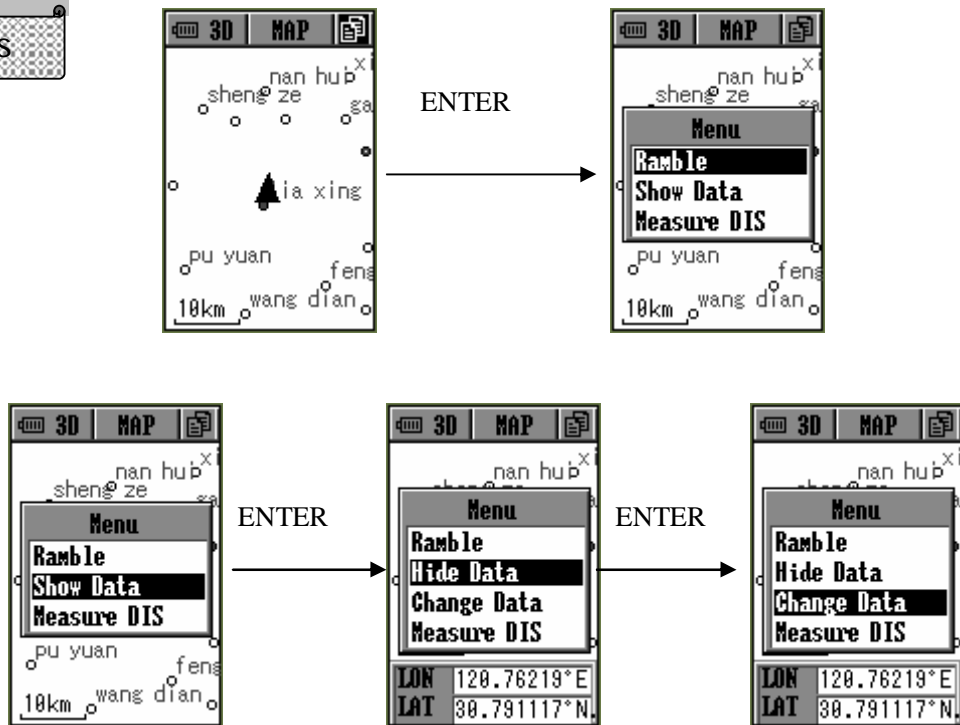

The Map page

This page shows the map information.

Use **left / right** can set the map scale, the use of the menu pages in the map information can be used **up / down** button to select **Ramble**, **Show Data**, **Measure DIS**.

Ramble: You can use **up / down / left / right** to view the vicinity map showing the location of the cursor position at the same time showed that, by switched button can return.

Show Data: the main display current location of latitude and longitude data, Press **Enter** key areas can choose to **Hide data** and **Change Data**, keys can be switched by the return.

Hidden data : hidden **longitude, latitude, heading, speed, altitude, distance, and other data**.

Change Data: What can show **longitude, latitude, heading, speed, altitude, distance, and other data**.

Measuring DIS: Measuring current location and the distance between the cursor position, also showed that perspective, the keys can be switched by the return.

After the elections, Press **Enter** keys to enter the "Save WPT" screen by switching on a screen button to return.

Enter

Each column for the anti-selected color, background color, Press **Enter** key to enter edit, edit success, bond set by the state to set aside editor, if editors want to jump out when the bond directly by switching from edit, edit circumstances is not the arrow keys can be switched according to the column.

Switching between preservation and use canceled about key. If they choose to preserve button will preserve this destinations in destinations table, the specific operation of flights from Table View.

Others: name each character can be installed in 26 case-sensitive letters and (0-9) 10 digital switching between; coordinate settings, each figure in the 0-9 intergovernmental transform, said latitude N, S said south latitude, said E N, W said W; height settings, each figure can be in the 0-9 intergovernmental transform, m length of said units meters installed after completion or retention of withdrawal or cancellation of operation.

Editing a Waypoint:

1. Press ENTER key in Waypoint List page and see a sub-menu
2. Press UP/ DOWN keys to highlight Edit item
3. Press ENTER key again and enter Waypoint Edit page
4. Now follow the step 4, 5 & 6 as described to build a Waypoint

Deleting a Waypoint:

1. Press ENTER key in Waypoint List page and see a sub-menu
2. Highlight Delete item by pressing UP/ DOWN keys
3. Press ENTER key and see a message "Delete WPT"
4. Choose Yes and press ENTER key to confirm your deletion; or choose No for cancellation

Sorting Waypoints:

Sorting waypoint is to list all the waypoints in alphabetic order. Press ENTER key in Waypoint List page and see a sub-menu. Press UP/ DOWN keys to highlight Sort item in Waypoint List page, and press ENTER key, then all the waypoints are relisted.

Reference

Editing Waypoints

Navigate a Waypoints:

If you want to use a waypoint for navigation, you must make it active first.

1. Press ENTER key in Waypoint List page and see a sub-menu(as destination)
2. Highlight Active item by pressing UP/ DOWN keys
3. Press ENTER key to confirm and GPS_DESIGNER begins to guide you to reach destination
4. Then, "Navigate" change into "Stop",if press ENTER key, guiding will stop .

DeleteAll:

Remove all waypoints.

1. Press ENTER key in Waypoint List page and see a sub-menu
2. Highlight DeleteAll item by pressing UP/ DOWN keys
3. Press ENTER key and see a message "Delete all WPT"
4. Choose Yes and press ENTER key to confirm your deletion; or choose No for cancellation

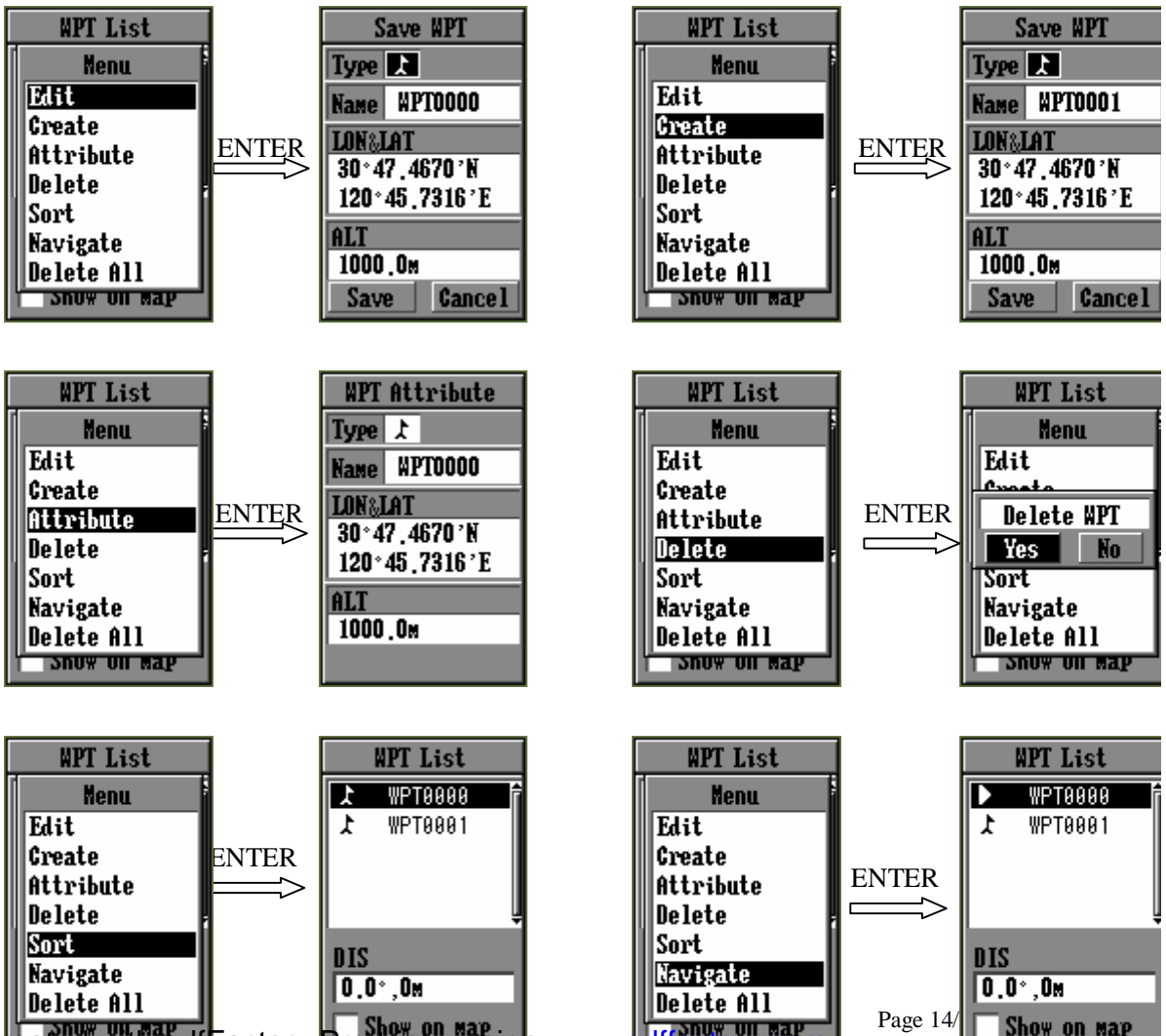

Creating a route

1. Press UP / DOWN keys to highlight R_LIST item in MENU page and press ENTER key
2. Coming to Routes List page, Press ENTER key
3. Press UP/ DOWN keys to highlight Create item and press ENTER key
4. Press ENTER key again
5. Highlight Add item by UP/ DOWN keys and press ENTER key
6. Coming to the page of Waypoint List, you choose any waypoint you want to set in this route by UP/ DOWN keys, then press ENTER key
7. Redo from step 4 to step 6 to add multi- waypoint into the route, Press ENTER key and highlight Save by pressing UP/DOWN keys.
8. Press ENTER key to finish creating a route.

The Route function allows you to link up a series of waypoints and guide to point by point, to a final destination. If there is a route made up of three waypoints A, B and C. Then the segments in travelling order from Waypoint A to Waypoint B, and from Waypoint B to Waypoint C are called “two legs” on the route.

The route can contain up to 50 waypoints(including start and destination) in GPS_DESIGNER using any of the waypoint stored in the memory.

In the page of Create a Route, highlight a waypoint by UP/ DOWN keys, and press ENTER key, pop up four operational options:

1. Add Waypoint is to put a waypoint behind the highlighted waypoint:
 - Press UP/ DOWN keys to highlight Add WPT item
 - Press ENTER key and enter Waypoints List page
 - Press UP/ DOWN keys to highlight the waypoint you want to add
 - Press ENTER key to confirm
2. Insert Waypoint is to put a waypoint in front of the highlighted waypoint
 - Press UP/ DOWN keys to highlight Insert WPT item
 - Press ENTER key and enter Waypoints List page
 - Press UP/ DOWN keys to highlight the waypoint you want to insert
 - Press ENTER key to confirm
3. Delete Waypoint is to remove a waypoint in a route
 - Press UP/ DOWN keys to highlight the waypoint you want delete
 - Press ENTER key, then the waypoint erased from the route
4. Save is to finish route edition and keep it in the unit memory
 - Press UP/ DOWN keys to highlight Save item
 - Press ENTER key and a mini-window pops up
 - Use LEFT/ RIGHT UP/ DOWN keys to name this route

reference

Creating a Route

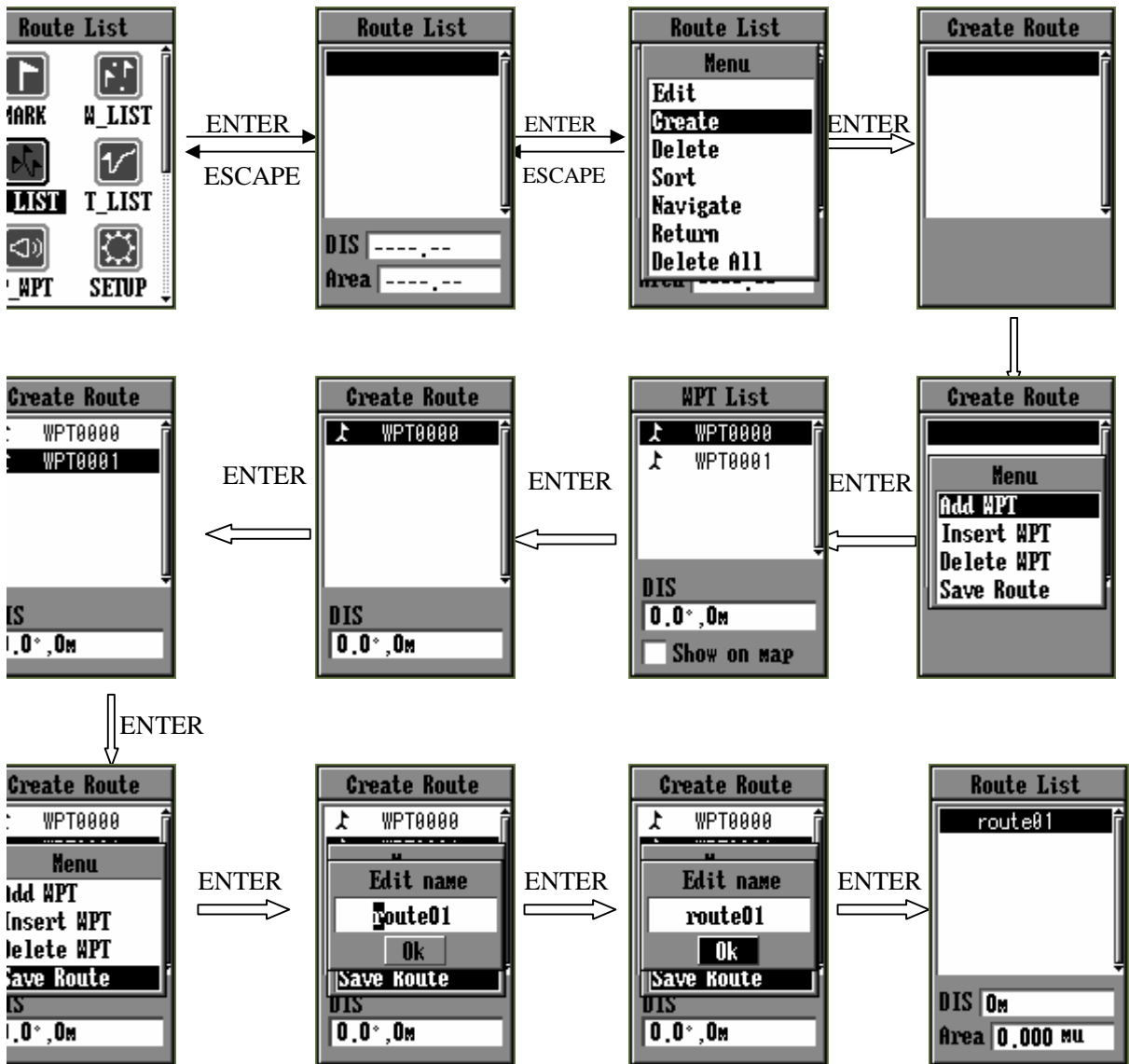

NOTE: When you are saving a route in route creation, if there is already a same named route existed in the memory, the unit will remind you to rename it.

Editing Route

In the page of Route List, you can browse all the routes you saved in GPS_DESIGNER. If you want to change a route, you can edit it by changing waypoints design:

1. Press UP/ DOWN keys to highlight the route you will change in the page of Route List
2. Press ENTER key and switch into the page of Edit This Route
3. You see all the waypoints along the route now, press ENTER key and pop up a sub-menu with four commands: Add (WPT), Insert (WPT), Delete (WPT) and Save(route). You can operate as stated above to change this route specifically.
4. In the end, don't forget to save your edition. Press UP/ DOWN keys and highlight Save item in the page of Edit This Route, press ENTER key and check the route name again. If you just want to keep it, only choose OK; If you want to change the name, just follow the steps in Save Route.

Deleting Route

In the page of Route List, if you want to delete a route:

1. Press UP/ DOWN keys to highlight the route you will delete in the page of Route List
2. Press ENTER key and highlight Delete item in the pop-up sub-menu by UP/ DOWN keys
3. Press ENTER key , and a prompt appears asking for your confirmation
4. Use LEFT/ RIGHT keys to highlight Yes and press ENTER key again, the route is deleted from the unit; otherwise press No, your deletion becomes invalid

Sorting Routes

1. Press UP/ DOWN keys to highlight any route in the page of Route List
2. Press ENTER key and highlight Sort item in the pop-up sub-menu by UP/ DOWN keys
3. Press ENTER key , and all the routes in the memory are listed in alphabetic order

Navigate Route

If you want to use a route for navigation, you must make it active first.

1. Press UP/ DOWN keys to highlight the route you will use for navigation in the page of Route List
2. Press ENTER key and highlight Active item in the pop-up sub-menu by UP/ DOWN keys
3. Press ENTER key , then the route is activated (a wait cursor appears beside the route), navigation from start to end work ,“Navigate” become to “Stop”. Then, if press ENTER key on it , guiding will stop .

Return Route

If you want to return along a route for navigation, you can use this function.

1. Press UP/ DOWN keys to highlight any route in the page of Route List
2. Press ENTER key and highlight Return item in the pop-up sub-menu by UP/ DOWN keys
3. Press ENTER key , then navigate from end back to start point (a wait cursor appears beside the route), “Return” become to “Stop” . Then ,if press ENTER key on it , guiding will stop .

Firstly, the five commands have the same functions and operation steps as explained above, secondly, they are only used for routes in navigation.

Once a route is activated, in the pop-up sub-menu, the five commands are used for route navigation. When you are using route navigation, you should switch to Tracking page to see your trace, and switch to Navigation page to find out your movement status, including LAT,LON, COG,SOG,ALT. In this way, you are enabled to find your way.

DeleteAll

Remove all Routes.

1. Press ENTER key in Route List page and see a sub-menu
2. Highlight DeleteAll item by pressing UP/ DOWN keys
3. Press ENTER key and see a message "Delete all routes"
4. Choose Yes and press ENTER key to confirm your deletion; or choose No for cancellation

NOTE:

- *You can not edit a route when it is in navigation.*

Recording a Track

1. Press UP/ DOWN keys in MENU page and highlight T-list item, press ENTER key and come into Track page
2. Press ENTER key and Track Edit window pops up
3. Press UP/ DOWN/ LEFT/ RIGHT keys to change letter and number to give the track a name
4. Press ENTER key to confirm your naming
5. Press ESCAPE key continuously till you return into the main page of Tracking

NOTE: If you input a name which has already existed in track library, you will be informed by a message “Name Existed”. In this case, you must change your naming. In GPS_DESIGNER, you can record at most 10 tracks in total, otherwise, a prompt “Memory Full” appears .

6. When you stop your tracking, switch into Track page again and highlight “Stop Record” , then press ENTER key.

NOTE: You may find your track not a continuous line in the display. That is because the satellite signal reception is not steady due to some high buildings, subways or magnetic field and etc.

Once you have some tracks recorded, you can rename and delete them, use one of them for navigation, and check its record time, distance , speed , area and state.

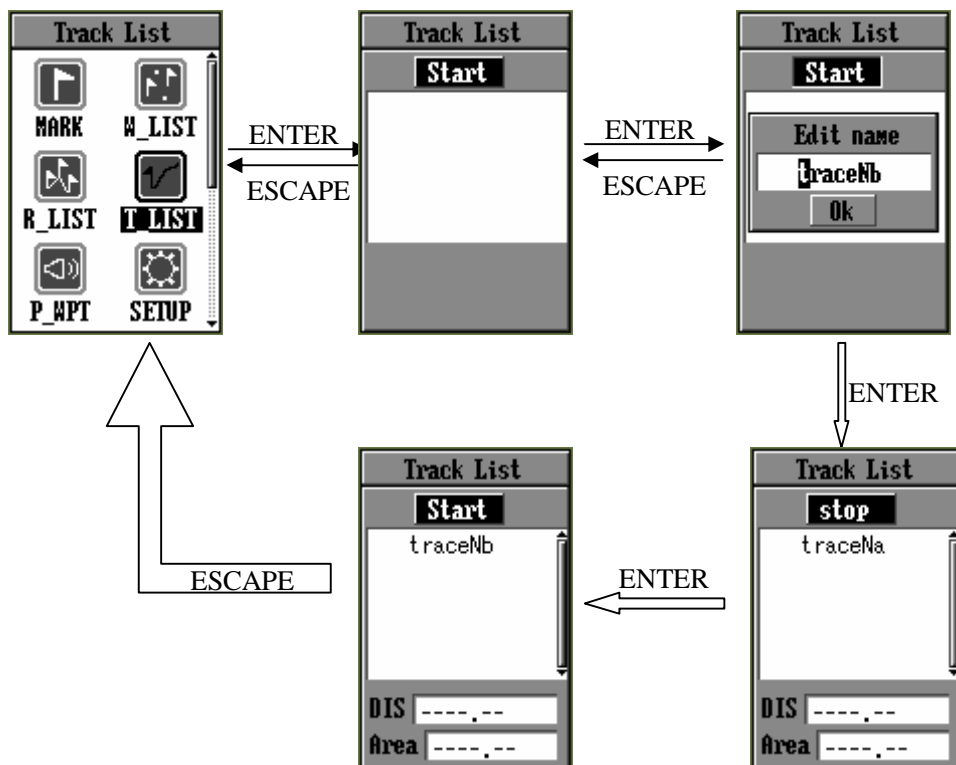

Return track

1. Press UP/ DOWN keys in Track page and highlight the track your want to use for navigation, press ENTER key and come out a sub-menu
2. Press UP/ DOWN keys to highlight Return item in the pop-up window
3. Press ENTER key again and Track Edit window comes out
4. Press UP / DOWN/ LEFT/RIGHT keys change the name of the track
5. Press ENTER key to confirm your input

Navigate track

1. Press UP/ DOWN keys in Track page and highlight the track your want to rename, and press ENTER key
2. Press UP/ DOWN keys to highlight Navigate item in the pop-up window
3. Press ENTER key again and Track Edit window comes out
4. Press UP / DOWN/ LEFT/RIGHT keys change the name of the track
5. Press ENTER key to confirm your input

Track's Attribute

1. Press UP/ DOWN keys in Track page and highlight the track your want to check, and press ENTER key
2. Press UP/ DOWN keys to highlight Attribute item in the pop-up window
3. Press ENTER key and trigger out another page, displaying record time, distance, status of the track

Deleting a track

1. Press UP/ DOWN keys in Track page and highlight the track your want to delete,press ENTER key and come out a sub-menu
2. Press UP / DOWN keys to highlight Delete item
3. Press ENTER key and a message comes to ask for your further confirmation
4. Choose Yes and press ENTER key, then the track is completely deleted from track library

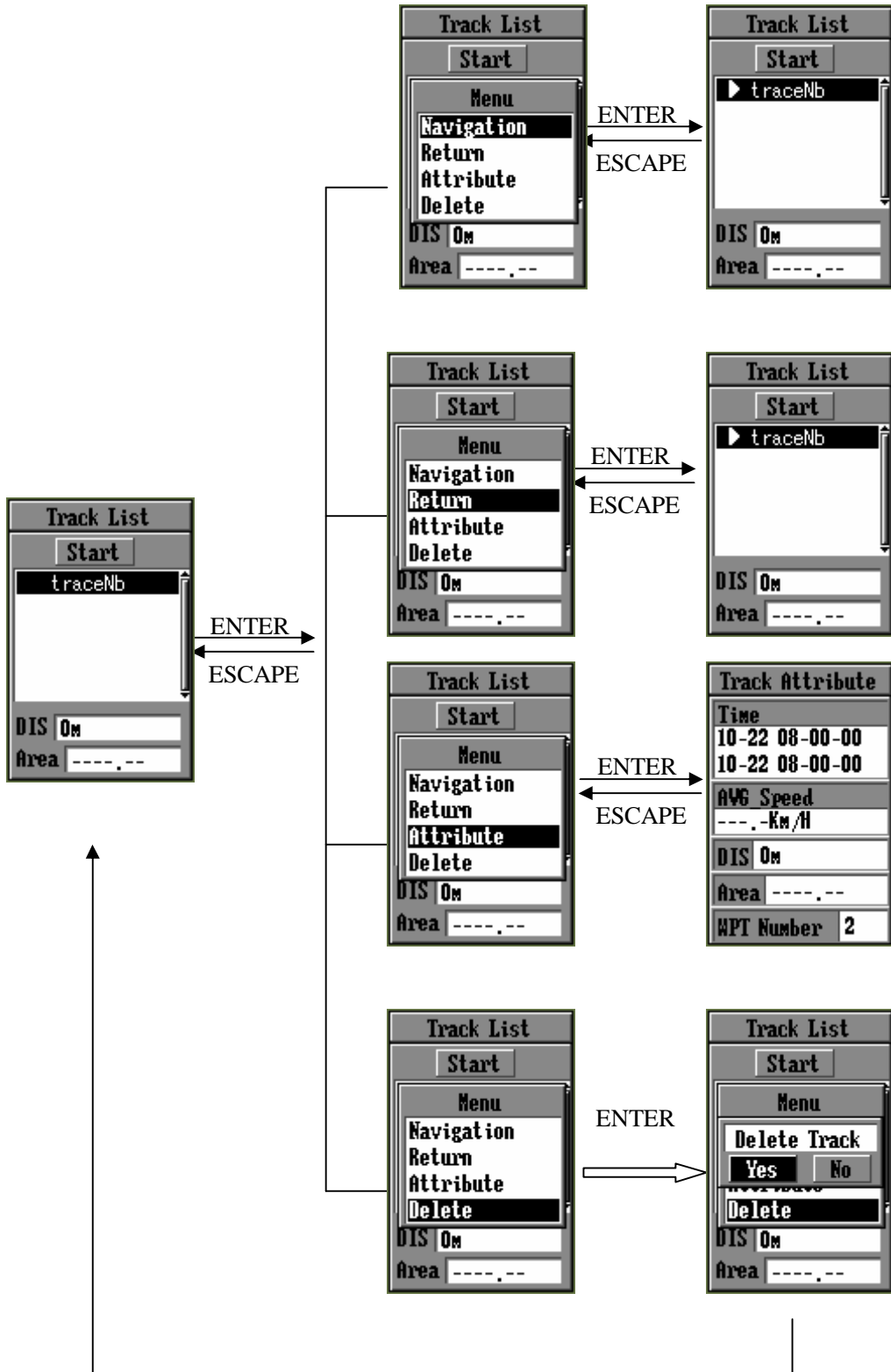

The warning is installed in the course of navigation, flight arrival flights automatically suggested that the police role, the most installed 10 alarm may flights. Specific operations, detailed look at the following steps:

1. Immigration destinations need to add the routes to warn column item
2. Outflow destinations removal routes alarm, delete destinations
3. Show flight destinations attributes View

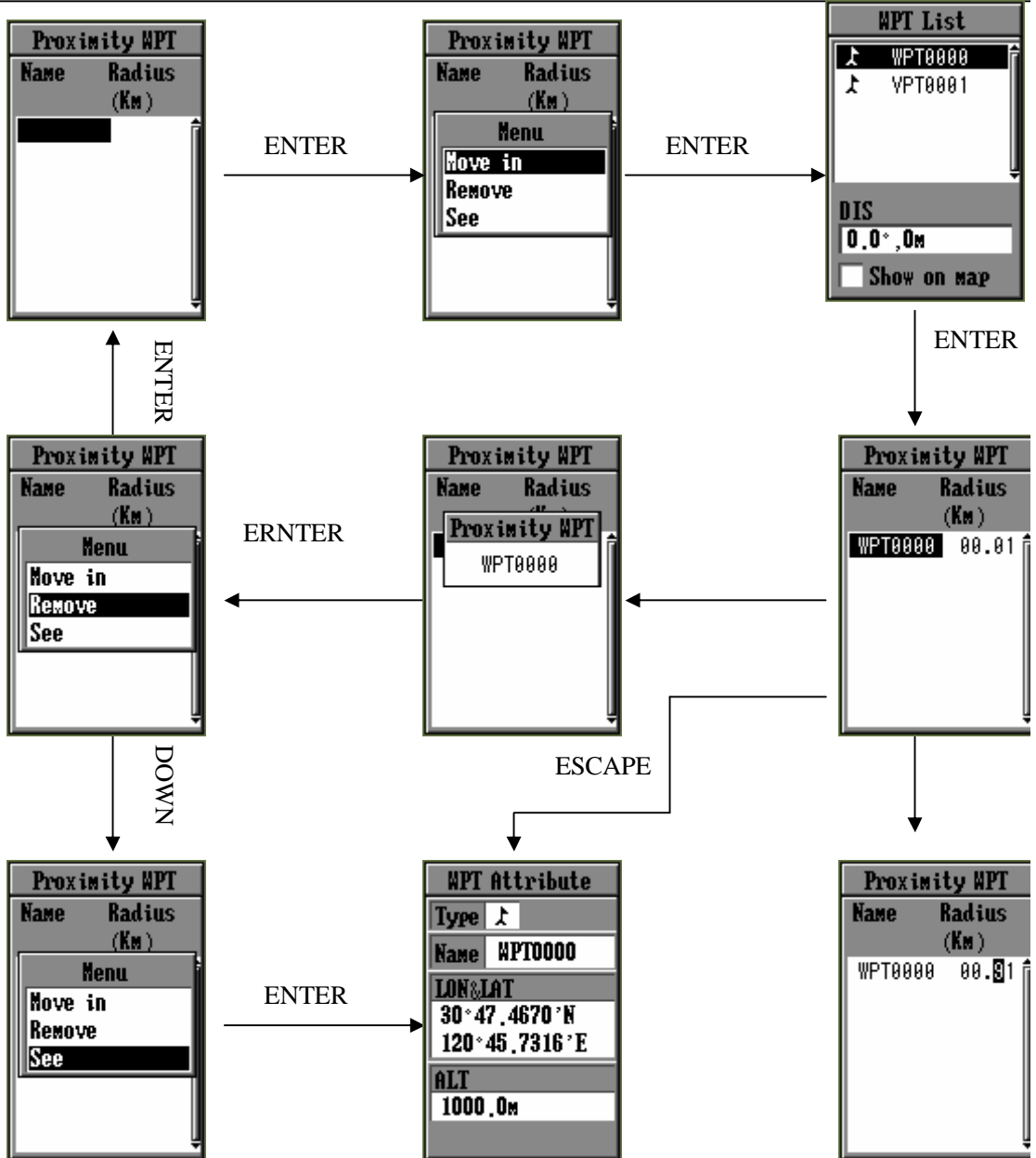

Setup

Highlight Setup item by UP/DOWN key and press ENTER key from Menu page, the Setup page appears. You can set 7 items for the system: Datum, Display, Time, Alarm, Unit and Other.

Sys

There are four items you can set: mode, record Manner, Battery Type, Restore.

Datum

Refers to the theoretical mathematical model of the earth's sea surface. Map makers may use a different model from which to chart their maps, so position coordinates will differ from one datum to another. The datum for the map you are using can be found in the legend of the map. If you are unsure as to which datum to use, just choose WGS84.

Unit

There are three unit available for you can set: Show Format, DIS Format, Area Format.

Time

You must choose time format first once you turn on the GPS_DESIGNER, it means you can read time in 12 hours or 24 hours. Then you need to set UTC (Universal Time Coordinate). In another word, if your present location is in +8 time zone, and you are using +8 time zone clock, you have to choose +8 hours. If you are in +8 time zone but using +6 time zone clock, you'd better choose +6 hours. If you choose 0 hour, that is exactly UTC Time. This setup is very important, it will directly affect the time displayed. Press LEFT/ RIGHT keys to select 12 hours or 24 hours; Press UP/ DOWN keys to select UTC time.

Alarm

In this item, you can set alarm for five kinds of subjects: XTE, Hazard, Destination, Landmark and Anchor.

Highlight the subject you want to put alarm by UP / DOWN key and press ENTER key.

- For XTE alarm, if you choose 0.2 mile, the alarm will work once your current leg goes out of the circle with 0.2 mile radius and the center of your current location. This function will only be available when the waypoint is within the route and the unit is set to navigation status.
- For Hazard alarm, If you select 0.2 mile, the unit will alarm automatically when you get into the circle, which is an area with the center of this Hazard and the radius of 0.2 miles. This function will only be available when the waypoint is within the route or track and the unit is set to navigation status.

Other

There are two items you can set: Light Time, Contrast.

NOTE:

you must set Hazard in waypoints list; otherwise this alarm does not work.

- For Destination alarm, it is the same as Hazard alarm.
- For Landmark alarm, if you choose ON for Landmark alarm and OFF for Destination alarm, the unit will alarm once you are within 0.1 unit (depending on your unit setup) away from each waypoint. If you choose ON for waypoint alarm and 0.2 mile for Destination alarm, the unit will work within 0.2 mile away from the each waypoint.
- For Anchor alarm, if you choose 0.2mile, the unit will alarm when you are 0.2 mile away from the location you set as Anchor .

reference

Setup

NOTE:

Whenever you start to use Anchor alarm, the unit will always default your current location as the Anchor. The prompt alarm will last until you go out of the alarm area or switch off the alarm. If you set Anchor alarm, it will always be effective no matter it is in the state of navigation or not, expect the alarm is turned off.

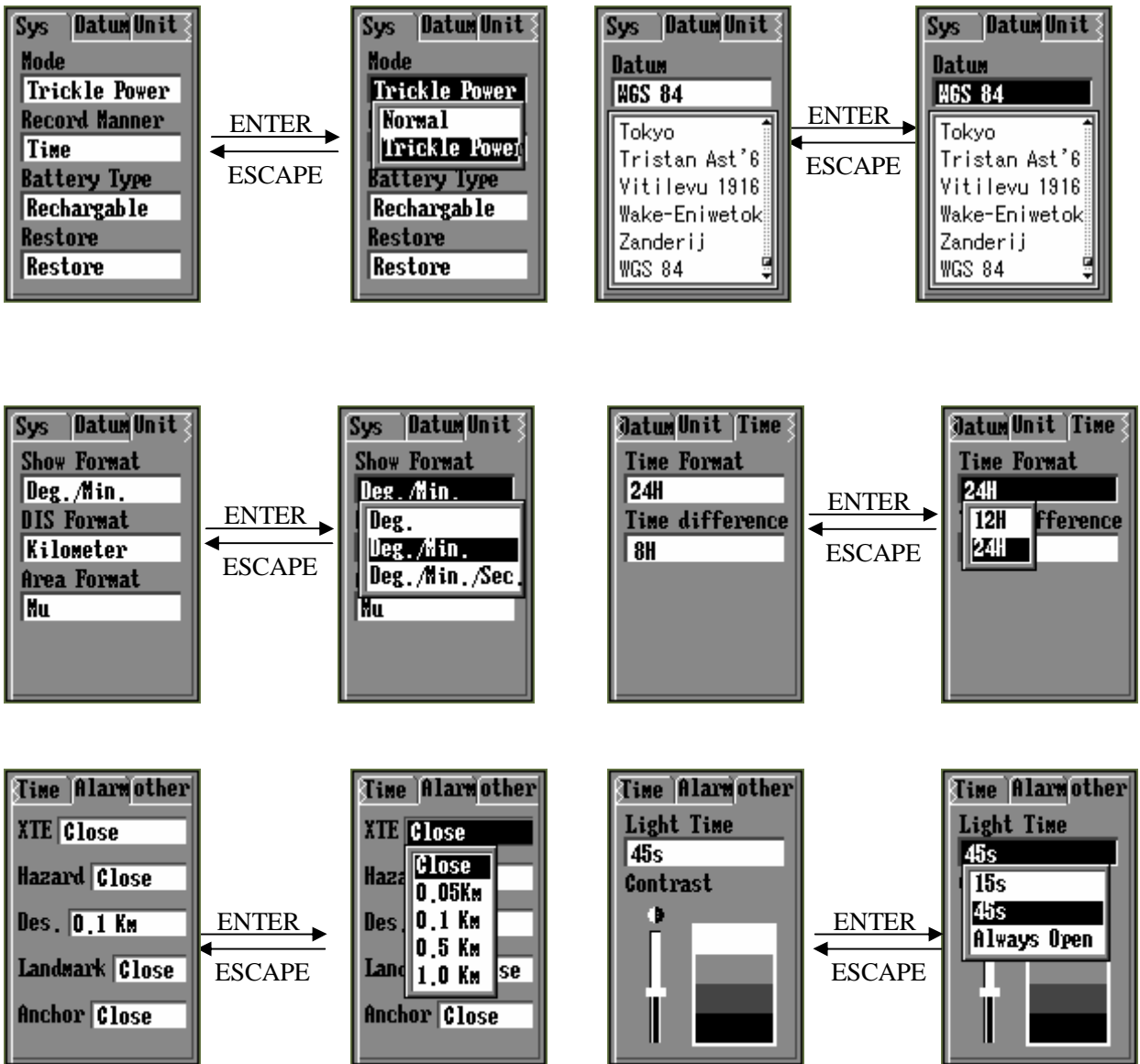

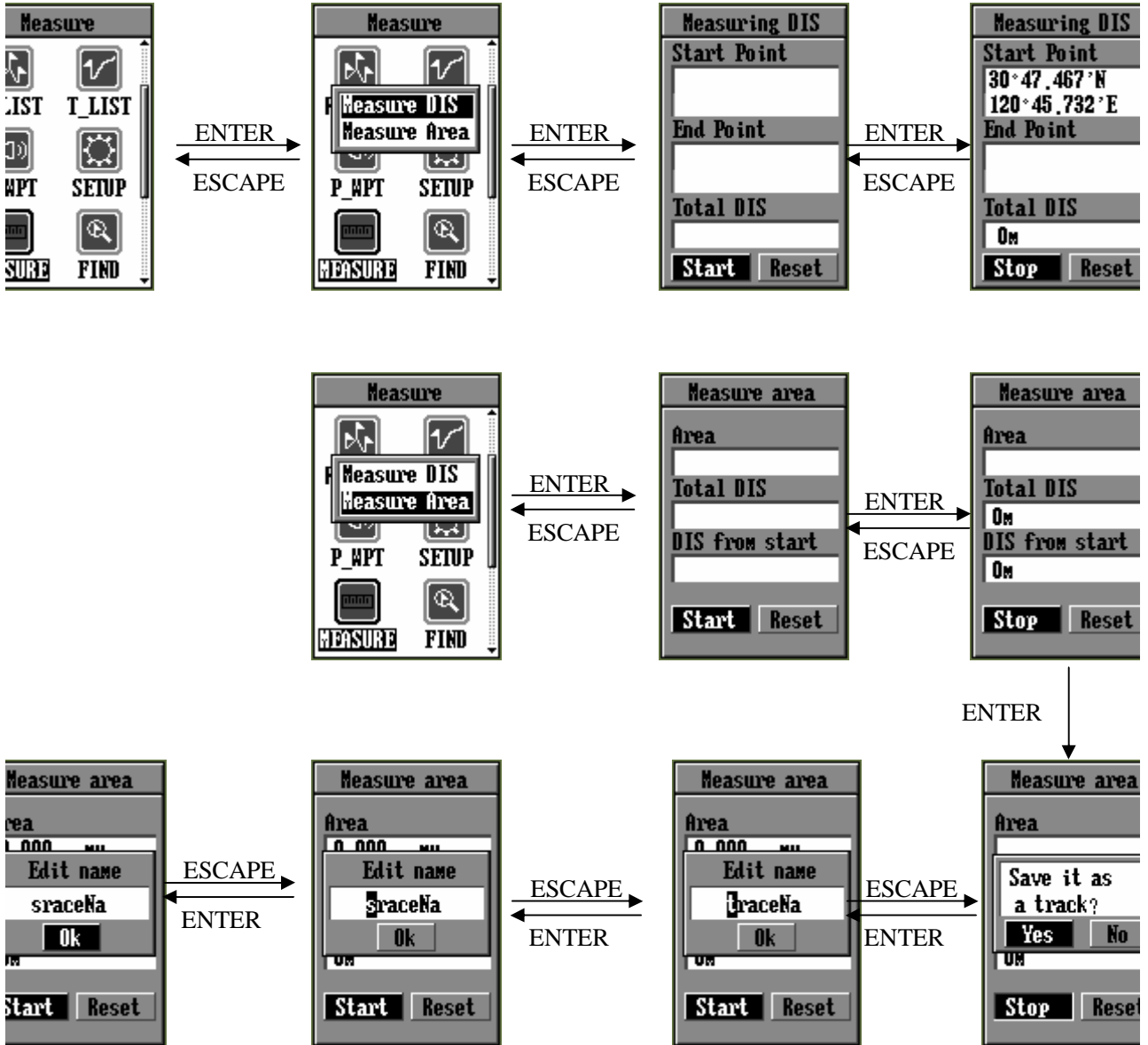

Tools options use **up/down** key selected by determining bond pop **Measure DIS** and **Measure Area** of the two options, Press **Enter** keys to be able to enter for further operation. **Measure DIS**, measurable starting point coordinates to the coordinates of the end of the distance between points . **Measure Area**, the measurement path can be closed area, at the same time can be saved for the track. At any one page, by **ESCAPE** key can return to the main menu.

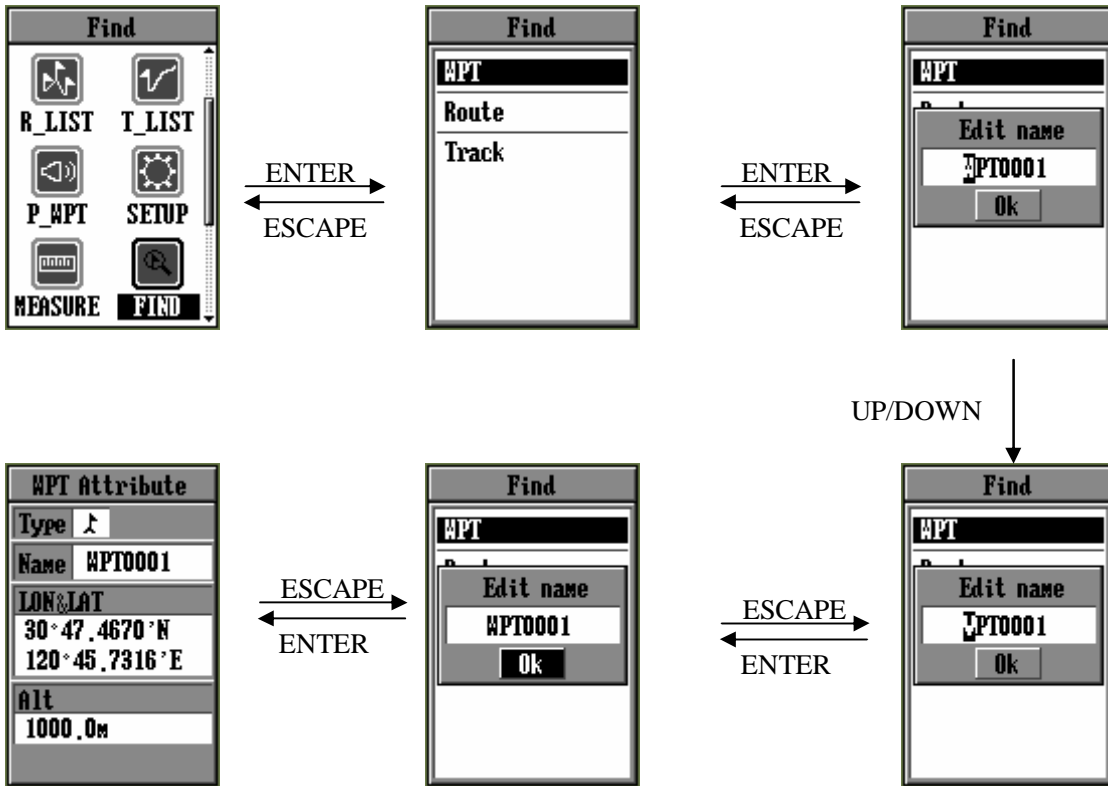

Find options, we can conduct **Waypoint, Routes, Track** the search.

If handhelds in the preservation of the relevant data, then you can search through the complete operation if not preserved relevant data, it will give a warning to show there is no relevant data.

For example, search **Waypoint**, you can use the menu **up / down** keys selected search options and then **Enter** key to enter View pages, you can use **up / down** button to select waypoint, routes, track, you can choose waypoint, according to determine bond after name pop up dialog editor, you can use the **up / down / left / right** to change name, followed by the completion of **Enter** key editorial said, then began to **Enter** key search, if there are flights from the flight so that the properties, depositors will not give warning.

Route or **Track** similar to the search.

In the **Hunt & Fish** options, you can view the best **Hunt & Fish** with a better time slot.

Press **up** / **down** key to choose measurement and measurement time.

According to determine bond, the use of **up** / **down** / **left** / **right** to amend measurement time and measurement, after proper revision, the bond can be **Enter** by the return of canceled by the choice of switching bond jumped out.

1. Modification time

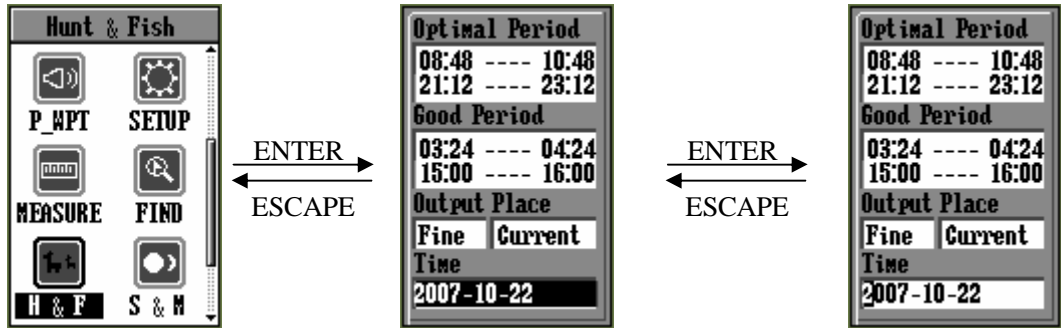

2. Measure to amend

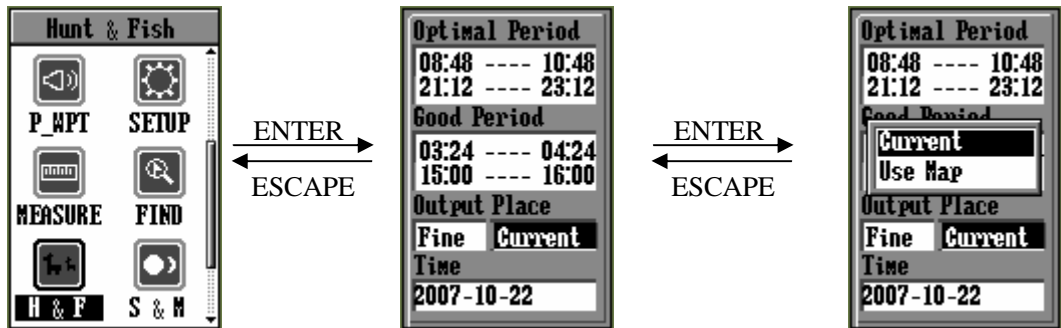

The Sun and provided some options in a certain place on a certain day of sunrise, sunset, moonrise, moonset, down on the time you travel convenience. The specific steps are as follows:

Press **up** / **down** button to choose measurement and measurement time.

1. Revised measurement time

After Press **Enter** key, the use of **up** / **down** / **left** / **right** time to amend the measure and amended good, you can press **Enter** return.

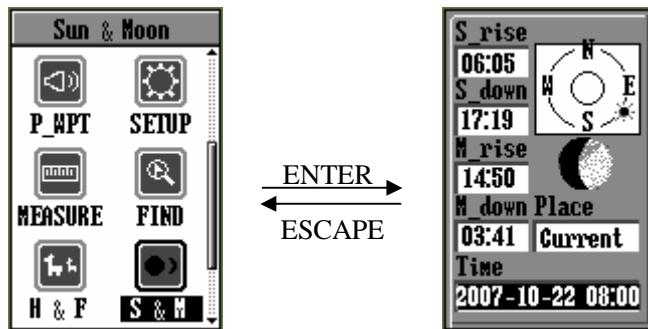

2. Revised measure to provide two options, the current positioning and map location of the measurement to determine the time, the choice of selected key measurement, by selected after press **Enter** key, jumped out after the text box by **up** / **down** keys to change the measurement.

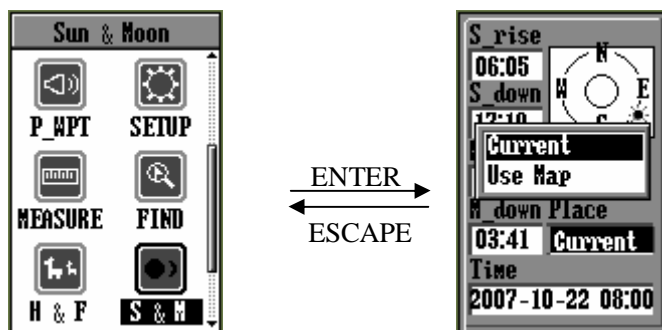

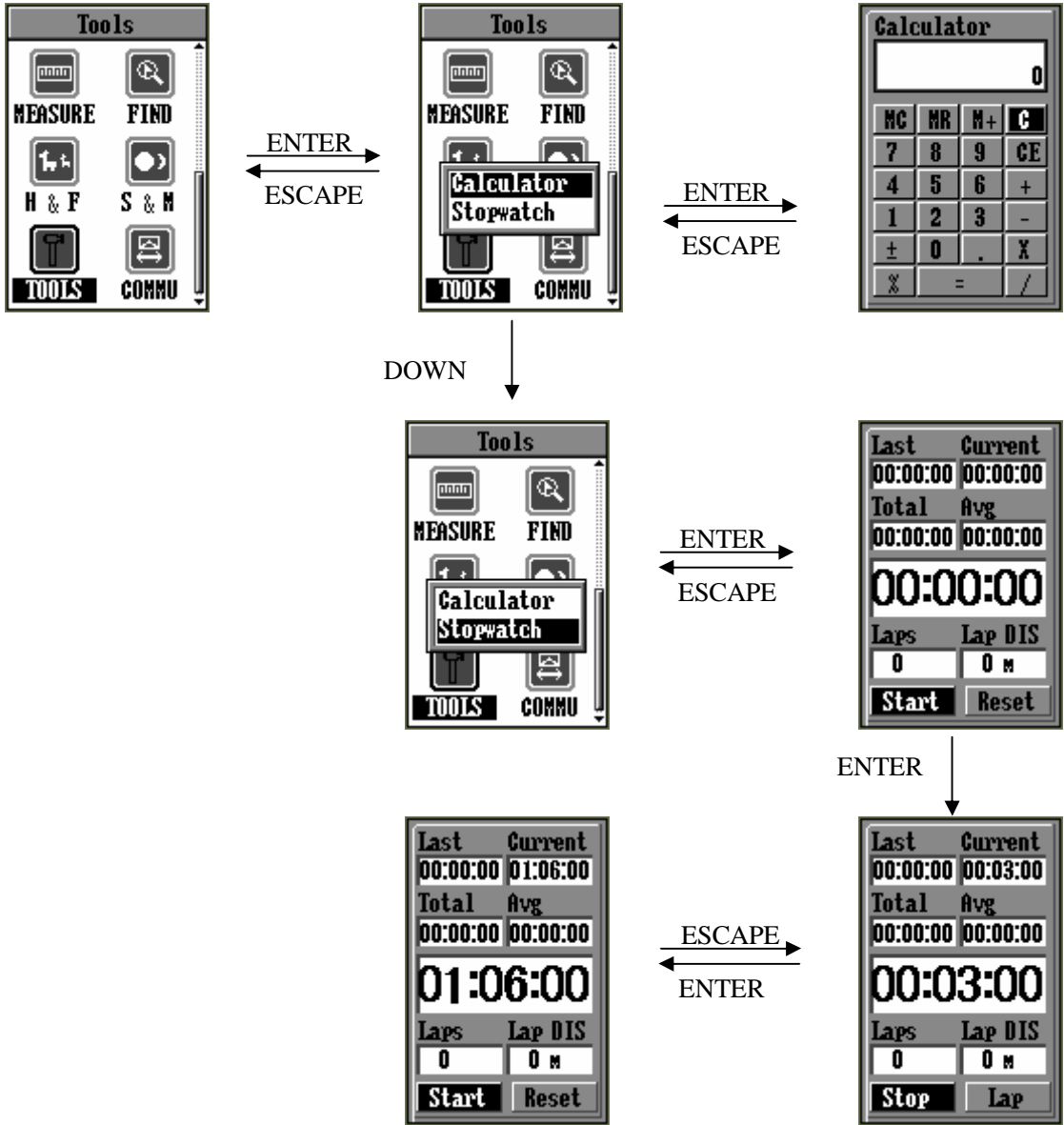

The tool options, you can use **calculator** and **stopwatch**.

Communication page

Highlight COMMU item by UP/DOWN key and press ENTER key from Menu page, the Setup page appears. It contains three items: Computer , Master ,Receive. It activates GPS_DESIGNER 's communication capability with a computer or a long-range equipment (for example , modem).

Computer:

With this function , GPS_DESIGNER can establish communication with a computer.

Master:

With this function , GPS_DESIGNER can establish communication with a long-range equipment (for example , modem) as a master.

Receive:

With this function , GPS_DESIGNER can establish communication with a long-range equipment (for example , modem)as a receiver.

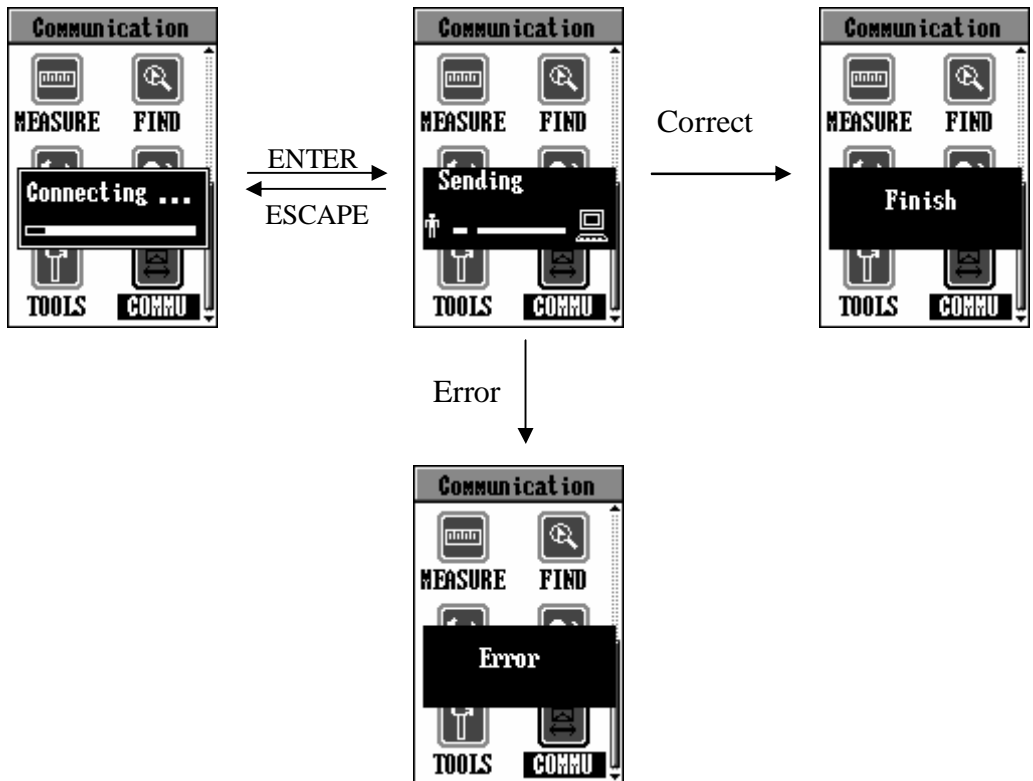

Altitude: Distance above mean sea level.

BRG: The compass direction from current position to next waypoint or the destination.

COG: Course over ground. Your direction of movement relative to a ground position.

Coordinate: A set of numbers that describes your location on or above the earth.

Course: GPS uses “Course” to define the movement direction of receiver on the globe surface instead of navigation direction.

Datum: A math model designed to fit part of the earth’s surface. Latitude and longitude lines on a paper map are referenced to a specific map datum. The map datum for a GPS receiver needs to match the datum listed on the corresponding paper map.

Distance: The linear length from current position to named waypoint or between two waypoints along a route.

DTD: Distance to Destination

DTW: Distance to the next Waypoint

Goto: A single leg route with the present position being the start of the route and a defined waypoint as the destination. You can use this function when you want to go directly to one of the waypoints saved in the memory. Select “Go to”, and then find out the waypoint you want. Confirm your selection and it starts navigation in this mode.

Latitude: The angular distance north or south of the equator measured by lines encircling the earth parallel to the equator in degrees from 0° to 90° .

Leg: A segment of a route that has a starting (From) waypoint and a destination (To) waypoint. A route may consist of one or more legs. For example, a route from Waypoint A to Waypoint B, to Waypoint C and to Waypoint D, has totally three legs from A to B, and from B to C, and from C to D.

Longitude: The angular distance east or west of the prime meridian (Greenwich meridian) as measured by lines perpendicular to the parallels and converging at the poles from 0° to 180° .

Parallel Channel Receiver: A continuous tracking receiver using multiple receiver circuits to track satellites simultaneously.

Position: Latitude and longitude, and altitude.

- Route:** A route consists of start point, end point and in-between waypoints. A single route is a kind of simple route only having start point and end point, in another word it is a “Goto” route. Route can also be made up of several legs from one waypoint reaching up to 20 other different waypoints.
- SOG:** Speed over ground. The actual speed the GPS_DESIGNER is moving over the ground. This may differ from airspeed or nautical speed due to such things as sea conditions or head winds.
- Speed:** The GPS receiver uses instantaneous speed to indicate practical moving speed.
- TRP:** Tracked route.
- True North:** The direction of the North Pole from your current position. Magnetic compasses are slightly incorrect due to effects of the Earth’s magnetic field while GPS units are more accurate for magnetic influences.
- Waypoint:** A permanently stored and named position in the GPS_DESIGNER’s memory.
- XTE:** Cross-Track Error.

1. The screen is blank after you press the POWER keypad.

- Wrong batteries installation or no enough power. Check to insure that the batteries are installed correctly and that the battery terminals are clean. Or replace the batteries.
- You may did not make valid operations (press is too light to start GPS_DESIGNER). Please press **POWER** key again till the unit responses and hear a sound “B” and see the welcome page.
- If you hear a sound “B”, then the GPS_DESIGNER is already turned on. You need to adjust screen contrast until you can recognize the words on the screen.

Please take a reference in page 3 on “ Turning the GPS_DESIGNER on”.

2. Battery choices

You can use alkaline battery or rechargeable battery in GPS_DESIGNER. But if you use rechargeable battery, the GPS_DESIGNER can not show you the correct information on the batteries condition.

3. Unavailability of satellite signals for long time

- Make sure you are operating the GPS_DESIGNER outdoors, not in a house or a covered building.
- Ensure the sky is clear and open since it will influence the satellite signals reception.
- Check your surroundings, there may be some electric or magnetic field around you or the GPS_DESIGNER which can interfere the normal work of GPS_DESIGNER, such as wireless radio station, radio tower or high-voltage wires and cables, and etc.

4. The GPS DESIGNER has water outside and inside

Wipe down the water outside of the GPS_DESIGNER with clean clothing. Put it in a windy place without direct sunshine and dry the inside. Then try to turn it on again to see if it works well. If it is still not good, please contact local maintenance agency. Never try to open the GPS_DESIGNER by yourself.

5. Though in open area with clear sky, the GPS DESIGNER can not track satellite.

- It's most because the GPS_DESIGNER had worked indoor for long time and been brought outdoor directly. Please turn off the GPS_DESIGNER outdoor and restart it.
- The GPS_DESIGNER is damaged. Please contact local dealer or supplier.

6. The GPS DESIGNER dropped or collided

Check the appearance completeness of the GPS_DESIGNER. Contact the local maintenance agency if you find the GPS_DESIGNER does not work well.

- **Navigation Features**

Waypoints:

Total: 1000 with name and symbol

Routes: 30 Reversible routes

Tracks: 10 tracks with name and symbol

- **Performance**

Receiver: Twelve parallel channel receiver continuously tracks and uses up to twelve Satellites

Frequency: L1,1575.42MHz,C/A code

Sensitivity: -140 dbm

Acquisition Times:

Hot : Approximately 10 seconds

Warm: Approximately 40 seconds

Cold: Approximately 60 seconds

Re-acquisition: Approximately less than 1 second

Update Rate: 2-seconds,continuous

Accuracy:

Position: 25 meters 2DRMS

Velocity: 0.1 knot RMS steady state

Dynamics: 2g's

Max.Height: 18000 meters

Max.Velocity: 100 m/s

Antenna: Built-in porcelain antenna

- **Physical**

Size: 120x54x30mm

Weight: 170g with 2 AA batteries

Display: 105x160 pixel, high-contrast LCD, electro-luminescent backlighting

Memory: Internal lithium battery backup lasts up to 10 years

- **Power**

Source: 2 AA batteries(or rechargeable batteries), 1.5V(1200mAH) each

Battery Life: Up to 16 hours

- **Temperature** Operation: -20~70° C

Storage: -30~80° C

Symbols

In the GPS_DESIGNER, you can use 28 symbols to name your waypoints (see them in the right part of the page).

Prompts

- **Maximum 30 routes can be saved!**
The GPS_DESIGNER can memorize maximum 30 routes, 10 tracks and 1000 waypoints. If you want to save more, you must delete some and spare space in the unit.
- **Deletion is invalid!**
When a waypoint or a track or a route is in navigation, you can not delete them.
- **No route can be used!**
There is no route in the memory at all.
- **Fail to delete waypoint, it is used by Goto!**
When a waypoint is used in Goto navigation, you can not delete or edit it.
- **Fail to edit waypoint, it is in use!**
The same as above.
- **Waypoint is wrong, it can not be saved!**
For a valid waypoint, its longitude covers from 0° to 180°, and latitude from 0° to 90°. Any waypoint defined out of this range is wrong or invalid.
- **Low Battery! It will shutdown automatically later.**
When the batteries are too weak to support operation, the unit will pop up this prompt.
- **In dangerous zone!**
Once you get into the area you set up as dangerous place, the GPS_DESIGNER will alarm you as soon as possible.
- **The track is unable to navigate.**
For GPS receiver, it can not identify position change within 25 - meter range.

 telephone kiosk	 incursion- border
 crossroad	 house
 fish pond	 rockfall
 slope	 dock
 flood	 hospital
 lake	 forbidden area
 fork in a road	 tree
 landslid	 danger zone
 broken roadway	 leakage
 expanded roadway	 service station
 camp-out	 station
 restaurant	 bridge
 human	 riverhead
 way-point	 airport

Adindan-Mean	Adindan-Regional Mean
Ala,Can,Conus	North American 1983-Alaska,Canada,Conus
Alaska	North American 1927-Alaska
Aleutian IsdE	North American 1927-Alaska(Aleutian Islands E)
Aleutian IsdW	North American 1927-Alaska(Aleutian Islands W)
Aleutian Isds	North American 1983-Aleutian Islands
Antarctica	Camp Area Astro-Antarctica
Arc-Mean	Arc 1950-Regional Mean
Argentina	South American 1969-Argentina
Argentina	Campo Inchauspe-Argentina
Australian 66	Australian Geodetic 1966
Australian 84	Australian Geodetic 1984
Bahama,Florid	Cape Canaveral-Bahamas,Florida
Bolivia 56	Provisional S.American 1956-Bolivia
Bolivia 69	South American 1969-Bolivia
Brazil	Corrego Alegre-Brazil
Brazil 69	South American 1969-Brazil
Brune,E.Malay	Timbalai 1948-Brunei,East Malaysia
C.America	North American 1927-Central America
C.Amer,Mexico	North American 1983-Central America,Mexico
C.Canada	North American 1927-Central Canada
Canada Mean	North American 1927-Mean for Canada
Canada yukon	North American 1927-Canada(Yukon)
Chile 63	Provisional S. Chilean 1963-Chile
Chile 69	South American 1969-Chile
Colombia 56	Provisional S.American 1956-Colombia
Colombia 69	South American 1969-Colombia
Conus Mean	North American 1927-Mean for Conus
Cuba	North American 1927-Cuba

Czechoslova42	S-42(Pulkovo 1942)-Czechoslovakia
Czechoslova93	S-JTSK-Czechoslovakia(prior to Jan 1993)
E.Canada	North American 1927-East Canada
E.Mississippi	North American 1927-East of Mississippi
Egypt 07	Old Egyptian 1907-Egypt
Egypt 50	European 1950-Egypt
England	Ord. Survey G. Britain 1936-England
Eur.C.Reg.M	European 1979-Central Regional Mean
Eur.E Reg.M	European 1950-Eastern Regional Mean
Eur.N.Reg.M	European 1950-Northern Regional Mean
Eur.S.Reg.M	European 1950-Southern Regional Mean
Eur.W.Reg.M	European 1950-Western Regional Mean
Finland Norway	European 1950-Finland,Norway
G.Britain M	Ord. Survey G. Britain 1936-Regional Mean
Greece	European 1950-Greece
Greenland	North American 1927-Greenland
Guam	Guam1963-Guam
Guyana	South American 1969-Guyana
Hawaii	Old Hawaiiin-Hawaii
Hawaii 83	North American 1983-Hawaii
Hawaii Mean	Old Hawaiiin-Regional Mean
Hong Kong	Hong Kong 1963-Hong Kong
Hungary	S-42(Pulkovo 1942)-Hungary
Iceland	Hjorsey 1955-Iceland
Indian 60	Indian 1960
India,Nepal	Indian-India,Nepal
Indonesia	Gunung Segara-Indonesia
Isle of Man	Ord. Survey G. Britain 1936- Isle of Man
Italy Sicily	European 1950-Italy(Sicily)

Japan	Tokyo-Japan
Kauai	Old Hawaiiin-Kauai
Kazakhstan	S-42(Pulkovo 1942)-Kazakhstan
Latvia	S-42(Pulkovo 1942)-Latvia
Maderia Isds	Porto Santo 1936-Maderia Islands
Malta	European 1950-Malta
Marshall	Wake-Eniwetok 1960-Marshall Islands
Maui	Old Hawaiiin-Maui
Mexico Gulf	North American 1927-Gulf of Mexico
Mexico	North American 1927-Mexico
Midway Isds	Midway Astro 1961-Midway Islands
Mindanao	Luzon-Philippines(Mindanao)
Montserrat Isd	Montserrat Island Astro 1958
Morocco	Merchich-Morocco
N.Chile	Provisional S.American 1956-Chile(Northern)
New Zealand49	Geodetic Datum 1949-New Zealand
New Georg Isd	DOS 1968-New Georgia Islands
New Zealand71	Chatham Island Astro 1971-New Zealand
Nw.Canada	North American 1927-Northwest Canada
Oahu	Old Hawaiiin-Oahu
Okinawa	Tokyo-Okinawa
Oman	Oman-Oman
Pakistan	Indian-Pakistan
Philippines	Luzon-Philippines
Paraguay	South American 1969-Paraguay
Peru 56	Provisional S.American 1956-Peru
Peru 69	South American 1969-Peru
Porland	S-42(Pulkovo 1942)-Poland
Romania	S-42(Pulkovo 1942)-Romania

Russia	Pulkovo 1942-Russia
S.Africa	Cap-South Africa
S.America M56	Provisional S.American 1956-Regional Mean
S.America M69	South American 1969-Regional Mean
S.Chile	Provisional S.American 1956-Chile(Southern)
S.Georgia Isd	ISTS 061 Astro 1968-South Georgia Islands
S.Greenland	Qornoq-Greenland(South)
S.Korea K	Korean Geodetic System-South Korea
Salvage Isds	Sevagem Grande-Salvage Islands
Sardinia 40	Rome 1940-Italy(Sardinia)
Sardinia 50	European 1950-Italy(Sardinia)
Saudi Arabia	Nahrwan-Saudi Arabia
Scotld,Shetld	Ord. Survey G. Britain 1936-Scotland,Shetland
South Korea T	Tokyo-South Korea
Soviet Sys.85	SGS 85-Soviet Geodetic system 1985
Taiwan	Hu-Tsu-Shan-Taiwan
Thai,Vietnam	Indian 1954-Thailand,Vietnam
Thailand 75	Indian 1975-Thailand
Toky-Mean	Tokyo-Regional Mean
United Arab	Nahrwan-United Arab Emirates
Uruguay	Yacare-Uruguay
Venezuela	Provisional S. American 1956-Venezuela
W. Canada	North American 1927-West Canada
W.Malay&Singa	Kertau 1948-West Malaysia & Singapore
W.Mississippi	North American 1927-West of Mississippi
Wales	Ord. Survey G. Britain 1936-Wales
WGS 72	WGS 1972-Global Definition
WGS 84	WGS 1984-Global DefinitionBolivia 56